

# HEAVY DUTY RAP-TIE

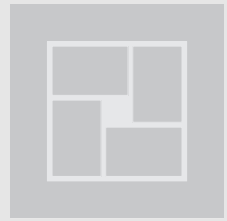

## HEAVY DUTY RAP-TIE APPLICATION

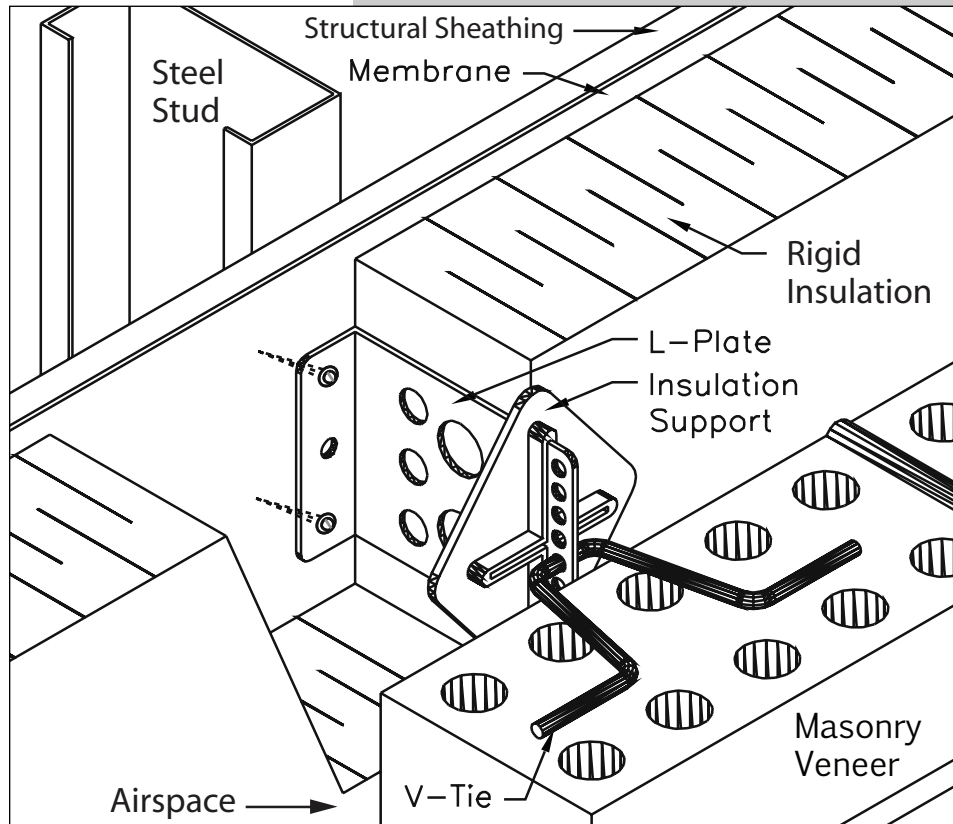

## Introduction

All FERRO masonry ties are in accordance with the following codes: **CSA A370, "Connectors for Masonry"** and **ACI 530/ASCE 5/TMS 402, "Building Code Requirements for Masonry Structures"**;

**CSA A370 (which references ASTM A123), ACI 530.1/ASCE 6/TMS 602 (which references ASTM A153, Class B), and the International Building Code (IBC) (which reference ASTM A153, Class B), in regards to hot-dip galvanized finish weight.**

The Heavy Duty Rap-Tie system consists of a Heavy Duty L-Plate (a vertically oriented L-shaped steel plate), a V-Tie™ (a V-shaped steel wire), and an Insulation Support. See *Figures 1, 2 and 3.*

Lateral loads acting on the masonry veneer are transferred through the V-Tie™ to the Heavy Duty L-Plate which bears against, and is fastened to, the structural backing. Attachment may be directly to poured concrete, CMU (through the web), wood stud, steel stud or by surface mounting to a sheathing over the stud, as shown in *Figures 4 and 5*, respectively. The holes along the outboard end of the Heavy Duty L-Plate through which the V-Tie™ is inserted, provides a positive connection, without the possibility of V-Tie™ disengagement during construction and in-service, and permits up to 61mm (2.4") of in-situ vertical adjustment so that a bed joint in the outer wythe will always be coincident with the V-Tie™.

## Introduction cont.

In most applications, the Heavy Duty Rap-Tie is designed to simply transfer the lateral load from the exterior masonry wythe (the veneer) axially to the structural backing, and a single fastener will usually prove adequate. However, by using two fasteners to attach the Heavy Duty L-Plate to the structural backing, shear forces as well as axial forces can be resisted by the Heavy Duty Rap-Tie to provide composite action between the masonry veneer and the structural backing. The entire wall thickness, including both veneer and structural backing, becomes effective in resisting lateral loads, offering reduced lateral deflections and increased lateral resistance (see FERO Stud Shear™ Connector or Block Shear™ Connector literature). A Heavy Duty Rap-Tie can be used for retro-fitting masonry veneer systems where reducing lateral deflection of the steel stud structural backing is a required intervention.

The Heavy Duty Rap-Tie can accommodate a range of insulation thicknesses, and is ideal for spanning large cavities, recommended for 102mm (4") and greater. The Heavy Duty L-Plate has sufficient length to accommodate the thickness of the cavity insulation, and further extends 18 mm (0.7") into the air space to expose its leading edge and facilitate in-situ placement of the V-Tie™ and optional Insulation Support. The V-Tie™ is inserted through the appropriate hole along the leading edge of the L-Plate, coincident with a mortar bed joint, so as to extend horizontally normal to the structural backing without reducing tie capacity. The legs of the V-Tie™ are positioned along the centreline of the veneer within the placement tolerances permitted by the building code having jurisdiction. Adjustment normal to the wall is facilitated by selecting an appropriate length of V-Tie™.

## Components and Specifications

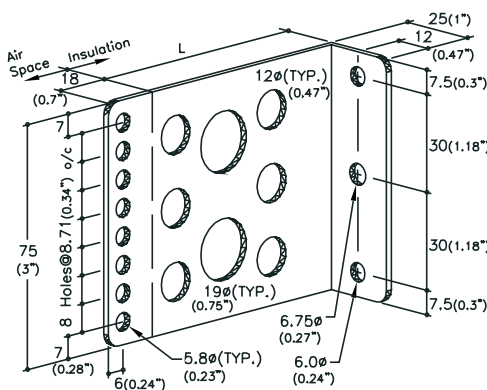

Figure 1 Heavy Duty L-Plate

**Heavy Duty L-Plate:** the Heavy Duty L-Plate is manufactured from 16 gauge sheet steel [1.367 mm (0.0538") minimum base steel thickness] and is available in both hot-dip galvanized finish and stainless steel. The incorporation of holes through the body of the Heavy Duty L-Plate minimizes thermal conductivity through the tie system. All FERO masonry ties are thermally broken with holes to minimize thermal conductivity.

The overall length of the Heavy Duty L-Plate is 18 mm (0.7") longer than the specification length (L) to accommodate the V-Tie™. The specification length is the total distance between the exterior face of the insulation and the exterior face of the component of the structural backing to which the Heavy Duty L-Plate is fastened/bears.

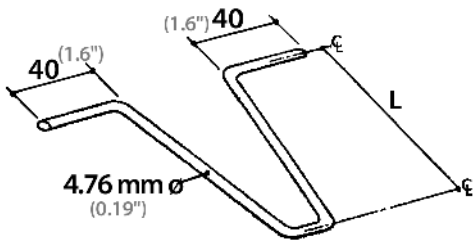

Figure 2 V-Tie™

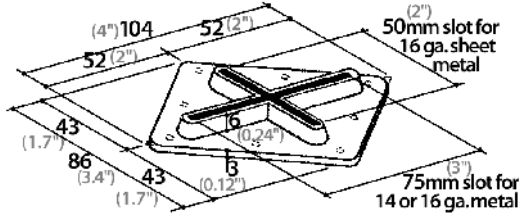

Figure 3 Insulation Support/Retainer

## Structural Composite Action

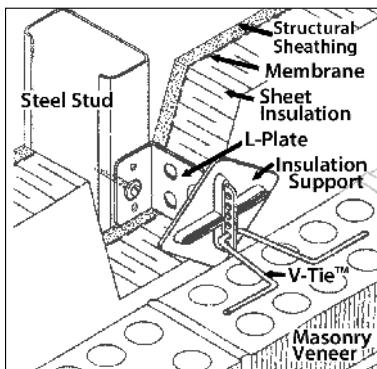

Figure 4 Heavy Duty Rap-Tie Attached Directly to a Steel Stud

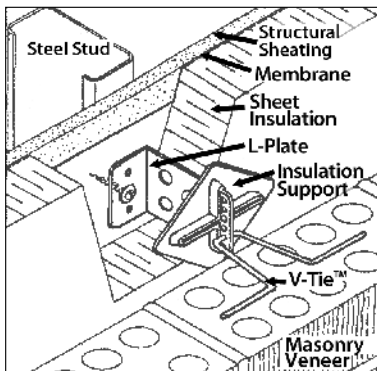

Figure 5 Heavy Duty Rap-Tie Surface mounted on Protected Structural Sheathing

**V-Tie™:** The V-Tie™ is manufactured from 4.76 mm (0.19") diameter steel wire and is available in both hot-dip galvanized finish and stainless steel stud.

The V-Tie™ is available in a variety of standard lengths to accommodate different specified thicknesses of masonry veneer and design widths of air space. Varying lengths of V-Tie™ can be used to accommodate construction tolerances where the constructed air space width differs from the designed air space width.

**Insulation Support:** The Insulation Support is manufactured from 100% polyethylene. The friction fit between the Insulation Support and the Heavy Duty L-Plate restrains the insulation during construction to prevent the insulation from separating from the structural backing/ air barrier. It is commonly installed in advance of the exterior masonry wythe. Subsequent installation of the V-Tie™ sandwiches the Insulation Support between the insulation and V-Tie™, thereby locking the Insulation Support in place and ensuring a reliable and permanent insulation support system.

Note: Refer to the FEROFASSTENERS brochure for complete specifications.

## Unit Masonry, Dimension Cut, and Manufactured Stone Veneer Applications

In addition to its use in unit masonry veneer applications (Figures 4 and 5), including both clay brick and concrete masonry, the Heavy Duty Rap-Tie system can be utilized in the application of stone or thin masonry veneer, as illustrated in Figure 6.

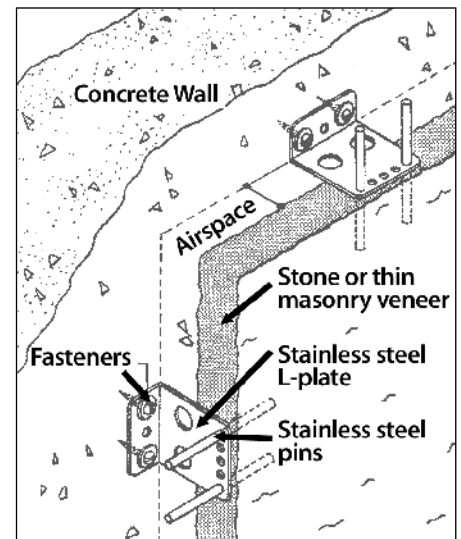

Figure 6 Heavy Duty Rap-Tie System Application for Dimension Cut Stone Veneer

# Heavy Duty Rap-Tie Design Data

Design data for the Heavy Duty Rap-Tie are reported separately for Canada and the United States in the following tables because design methods and requirements for masonry ties and their uses differ between their respective codes and standards.

## Heavy Duty Rap-Tie Design Data (Canada)

Design Parameter	Design Data <sup>(i),(iii)</sup>	
1. Mechanical Free Play <sup>(iv)</sup> (with FERO V-Tie™)	0.80 mm (max.) [0.031"]	
2. Serviceability at 0.45 kN [100 lbs] <sup>(iv)</sup>	Tie Mounted Directly to Steel Stud	Tie Mounted on Surface of Protected Exterior Gypsum Sheathing over Steel Stud <sup>(ii)</sup>
Deflection	0.47 mm [0.019"]	0.50 mm [0.02"]
Deflection + Mechanical Free Play	1.27 mm (max.) [0.05"]	1.30 (max.) [0.051"]
3. Factored Resistance ( $\phi P_{ult}$ ) <sup>(v),(vi),(vii)</sup>	1.51 kN [331 lbs.]	
4. Maximum Recommended Spacing <sup>(viii)</sup>	Horiz.	Vert.
	800 mm [32"]	600 mm [24"]

## Notes:

- (i) These design data are based on connector testing in accordance with CSA A370-14, Connectors for Masonry, with no surcharge and with test samples having the following configuration: 127 mm [5"] cavity; 102 mm [4"] Heavy Duty L-Plate; no insulation; one (1) fastener located in the centre hole of the L-Plate; standard FERO V-Tie™; and V-Tie™ engaged into L-Plate at position of maximum vertical adjustment. Smaller cavity widths and/or the addition of rigid insulations providing lateral support to the tie L-Plate will increase the tabled factored resistance of the tie and reduce tie deflection.
- (ii) Protected exterior structural sheathing consisting of Perma-Barrier (W.R. Grace) adhered to 12.7 mm (0.5") exterior gypsum board.
- (iii) These design data reflect both the windward (compression) and leeward (tension) capacities of the Heavy Duty Rap-Tie system, with the governing values listed.
- (iv) The Heavy Duty Rap-Tie satisfies the limiting requirements for serviceability (tie displacement and mechanical free play) in CSA A370-14. Tabled mechanical free play is for stainless steel components. The mechanical free play for hot-dip galvanized components is less.
- (v) The ultimate strength of the Heavy Duty Rap-Tie,  $P_{ult}$ , is determined in accordance with CSA A370-14 and is calculated by multiplying the average tie strength established by testing by  $(1 - 1.64 cov)$ . The factored resistance of the tie system ( $\phi P_{ult} = \phi R$ ) is calculated using the Limit States Design procedures of CSA A370-14.
- (vi) The stated tie factored resistance does not consider fastener resistance. A compatible fastener (or fasteners) having an adequate factored resistance must be selected (by design in accordance with CSA A370-14).
- (vii) The factored resistance of the mortar pull-out or push-through for the V-Tie™ embedded at the centreline of 90 mm (3.5") brick veneer utilizing Type S or N mortar exceeds or equals the tabled factored resistance,  $\phi P_{ult}$ . Failure by pull-out/push-through of the mortar joint does not govern.
- (viii) Maximum recommended tie spacings are the maximum spacings permitted by CSA S304-14, Design of Masonry Structures. For a particular design, the actual tie spacings are calculated such that the factored resistance of the tie,  $\phi P_{ult}$ , equals or exceeds the effect of factored loads. See S304-14 for the design of masonry veneer systems.

# Heavy Duty Rap-Tie

## Design Data

### Heavy Duty Rap-Tie Design Data (U.S.)

Design Parameter	Design Data <sup>(i),(iii)</sup>	
1. Mechanical Free Play <sup>(iv)</sup>	0.31" (max.) [0.80 mm]	
2. Serviceability at 0.45 kN [100 lbs] <sup>(iv)</sup>	Tie Mounted Directly to Steel Stud	Tie Mounted on Surface of Protected Exterior Gypsum Sheathing over Steel Stud <sup>(ii)</sup>
Deflection	0.019" [0.47 mm]	0.02" [0.50 mm]
Deflection + Mechanical Free Play	0.05" (max) [1.27 mm]	0.051" (max) [1.30 mm]
3. Nominal Strength <sup>(v),(vi),(vii),(ix),(x)</sup>	452 lb [2.01 kN]	
4. Recommended Design Load <sup>(v),(vi),(vii),(ix),(x)</sup>	200 lb [0.89 kN]	
5. Maximum Recommended Spacing <sup>(viii)</sup>	Horiz.	Vert.
	32" [813 mm]	18" [457 mm]

### Notes:

- (i) These design data are based on connector testing in accordance with CSA A370-14, Connectors for Masonry, with no surcharge and with test samples having the following configuration: 5" [127 mm] cavity; 4" [102 mm] Heavy Duty L-Plate; no insulation; one (1) fastener located in the center hole of the L-Plate; standard FERO V-Tie™; and V-Tie™ engaged into L-Plate at position of maximum vertical adjustment. The test method for ties in CSA A370-14 is comparable to that of ASTM E754, *Test Method for Pullout Resistance of Ties and Anchors Embedded in Masonry Mortar Joints*, and provides similar and more conservative results. Smaller cavity widths and/or the addition of insulations providing lateral support to the tie L-Plate will increase the nominal strength of the tie and reduce tie deflection. Prescriptive requirements for anchored masonry veneer under ACI 530.1/ASCE 6/TMS 602 limit the cavity to a maximum width of 4-1/2" (114 mm) unless the veneer is alternatively designed using a rational, engineered design method (termed "Alternative Design of Anchored Masonry Veneer").
- (ii) Protected exterior structural sheathing consisting of Perma-Barrier (W.R. Grace) adhered to 12.7 mm (0.5") exterior gypsum board.
- (iii) These design data reflect both the windward (compression) and leeward (tension) capacities of the Heavy Duty Rap-Tie system, with the governing values listed.
- (iv) The Heavy Duty Rap-Tie L-Plate with V-Tie™ satisfies the 1/16" (1.6 mm) maximum permissible clearance between connecting parts required by ACI 530.1/ASCE 6/TMS 602. Tabled mechanical free play is for stainless steel components. The mechanical free play for hot-dip galvanized components is less.
- (v) The nominal strength of the Heavy Duty Rap-Tie is determined by test and is reported as the average ultimate strength of the tie samples. In accordance with ACI 530.1/ASCE 6/TMS 602, using Strength Design, a suitable strength-reduction factor must be applied to the nominal strength to determine the tie design strength. Similarly, under Allowable Stress Design, an appropriate safety factor must be applied to determine an allowable load value. The tabled "Recommended Design Load" reflects a safety factor of 2.25 (that is, 75% of 3.0). [See also Note (vii) when assigning a strength-reduction factor to the nominal strength].

- (vi) The stated nominal strength and recommended design load do not consider fastener capacity. A compatible fastener (or fasteners) having an adequate strength must be selected (by design in accordance with ACI 530.1/ASCE 6/TMS 602).
- (vii) The nominal strength (and corresponding recommended design load) of the mortar pull-out or push-through for the V-Tie™ embedded at the centerline of 3.5" (90 mm) brick veneer utilizing Type M, S or N mortar exceeds or equals the tabled nominal strength (and recommended design load). Failure by pull-out/push-through of the mortar joint does not govern.
- (viii) Maximum recommended tie spacings are the maximum spacings permitted by ACI 530.1/ASCE 6/TMS 602 using prescriptive requirements for anchored masonry veneer. The prescriptive requirements in ACI 530.1/ASCE 6/TMS 602 further limit a tie tributary area to not more than 2.67 ft<sup>2</sup> (0.25 m<sup>2</sup>) wall area [with reduced areas for high Seismic Design Categories and in areas of high winds] unless the veneer is alternatively designed using a rational, engineered method (termed "Alternative Design of Anchored Masonry Veneer"). Where an Alternative Design is used, the required tie spacing may be calculated such that the design strength of the tie equals or exceeds the required strength. See ACI 530.1/ASCE 6/TMS 602 for the design of masonry veneer systems.
- (ix) The Heavy Duty Rap-Tie L-Plate with V-Tie™ satisfies ACI 530.1/ASCE 6/TMS 602 requirements for minimum wire size of W1.7 (MW11) and for ends bent to form a minimum 2 in (50.8 mm) extension.

**Copyright © 2014-2021 FERO Corporation**

FERO®, FERO Thermal Tie™, Rap-Tie®, Stud Shear®, FERO V-Tie™, L-Plate® are registered trademarks of FERO Corporation.

The FERO family of Masonry Wall Connectors, as installed, may fall within the scope of one or more issued patents or pending patent applications, according to the applicable installation type. Those patents include US 8,051,621; US 8,555,595; US 8,893,452 and corresponding Canadian Patents CA 2 566 552; CA 2 700 636; and CA 2 804 542.



**FERO Corporation**

15305 - 117 Avenue, Edmonton, Alberta T5M 3X4

Phone: (780) 455-5098 Fax: (780) 452-5969

[www.ferocorp.com](http://www.ferocorp.com) [engineering@ferocorp.com](mailto:engineering@ferocorp.com)